

**B&R** 0 212 280 30 73 - 0 212 268 33 99 - 0 212 280 96 85  
**BARKIN RULMAN HIZMAT SAN.TİC LTD STİ**

Adres : OTO SANAYİ SİTESİ ULUBAŞ CAD. NO.3 4.LEVENT/İSTANBUL

LÜTFEN İSKONTO ORANLARINIZI SORUNUZ



PARÇA NO	FİYAT/USD	PARÇA NO	FİYAT/USD	PARÇA NO	FİYAT/USD
GE 6 E	\$0,8	GE 20 ES-2RS	\$1,9	KR 16 PP	\$2,1
GE 8 E	\$0,8	GE 25 ES-2RS	\$2,6	KR 19 PP	\$2,6
GE 10 E	\$0,8	GE 30 ES-2RS	\$2,9	KR 22 PP	\$3,3
GE 12 E	\$0,9	GE 35 ES-2RS	\$3,9	KR 26 PP	\$3,4
GE 15 ES	\$1,0	GE 40 ES-2RS	\$4,8	KR 30 PP	\$4,1
GE 17 ES	\$1,2	GE 45 ES-2RS	\$5,7	KR 32 PP	\$4,4
GE 20 ES	\$1,5	GE 50 ES-2RS	\$7,8	KR 35 PP	\$6,0
GE 25 ES	\$2,1	GE 60 ES-2RS	\$12,9	KR 40 PP	\$7,3
GE 30 ES	\$2,4	GE 70 ES-2RS	\$17,5	KR 47 PP	\$10,8
GE 35 ES	\$3,2	GE 80 ES-2RS	\$25,8	KR 52 PP	\$11,5
GE 40 ES	\$4,2	GE 90 ES-2RS	\$34,2	KR 62 PP	\$18,2
GE 45 ES	\$5,0	GE100 ES-2RS	\$47,2	KR 72 PP	\$22,3
GE 50 ES	\$6,8	GE110 ES-2RS	\$53,0	KR 80 PP	\$35,1
GE 60 ES	\$12,0	GE120 ES-2RS	\$93,7	KR 90 PP	\$41,2
GE 70 ES	\$17,4	GE140 ES-2RS	\$151,8		
GE 80 ES	\$24,6	GE160 ES-2RS	\$200,3	NATR 05 PP	\$4,20
GE 90 ES	\$32,3	GE180 ES-2RS	\$256,0	NATR 06 PP	\$4,20
GE 100 ES	\$45,2	GE200 ES-2RS	\$365,8	NATR 08 PP	\$4,40
GE 110 ES	\$51,7	GE220 ES-2RS	\$460,4	NATR 10 PP	\$5,80
GE 120 ES	\$90,5	GE240 ES-2RS	\$522,5	NATR 12 PP	\$6,60
GE 140 ES	\$148,6			NATR 15 PP	\$7,40
GE 160 ES	\$193,8			NATR 17 PP	\$9,00
		GEEM 20 ES-2RS	\$3,0	NATR 20 PP	\$10,30
		GEEM 25 ES-2RS	\$3,5	NATR 25 PP	\$11,60
GEG 20 ES-2RS	\$3,2	GEEM 30 ES-2RS	\$4,2	NATR 30 PP	\$14,20
GEG 25 ES-2RS	\$4,0	GEEM 35 ES-2RS	\$5,1	NATR 35 PP	\$16,20
GEG 30 ES-2RS	\$5,5	GEEM 40 ES-2RS	\$6,3	NATR 40 PP	\$23,30
GEG 35 ES-2RS	\$6,4	GEEM 45 ES-2RS	\$8,5	NATR 45 PP	\$25,80
GEG 40 ES-2RS	\$8,5	GEEM 50 ES-2RS	\$10,4	NATR 50 PP	\$29,10
GEG 45 ES-2RS	\$10,4	GEEM 60 ES-2RS	\$17,5		
GEG 50 ES-2RS	\$17,4	GEEM 70 ES-2RS	\$28,4	NUKR 35	\$8,90
GEG 60 ES-2RS	\$26,1	GEEM 80 ES-2RS	\$38,4	NUKR 40	\$16,20
GEG 70 ES-2RS	\$35,4			NUKR 47	\$19,40
GEG 80 ES-2RS	\$44,1	GEZ 15 ES	\$1,8	NUKR 52	\$22,60
GEG 90 ES-2RS	\$61,6	GEZ 19 ES	\$1,9	NUKR 62	\$23,20
GEG100 ES-2RS	\$66,2	GEZ 22 ES	\$2,0	NUKR 72	\$38,80
		GEZ 25 ES-2RS	\$2,7	NUKR 80	\$51,70
		GEZ 31 ES-2RS	\$4,2	NUKR 90	\$54,90
		GEZ 34 ES-2RS	\$5,4		
		GEZ 38 ES-2RS	\$6,7	NUTR 15	\$5,50
GAC 25 S	\$10,5	GEZ 44 ES-2RS	\$9,6	NUTR 17	\$7,60
GAC 28 S	\$11,6	GEZ 50 ES-2RS	\$12,3	NUTR 20	\$8,40
GAC 30 S	\$12,8	GEZ 57 ES-2RS	\$17,0	NUTR 25	\$9,70
GAC 35 S	\$13,9	GEZ 63 ES-2RS	\$23,0	NUTR 30	\$18,10
GAC 40 S	\$15,1	GEZ 69 ES-2RS	\$31,0	NUTR 35	\$22,00
GAC 45 S	\$16,2	GEZ 76 ES-2RS	\$34,8	NUTR 40	\$22,80
GAC 50 S	\$19,7	GEZ 82 ES-2RS	\$46,6	NUTR 45	\$24,20
GAC 60 S	\$26,1	GEZ 88 ES-2RS	\$56,5	NUTR 50	\$27,00
GAC 70 S	\$31,3	GEZ 95 ES-2RS	\$73,2		
GAC 80 S	\$46,5	GEZ101 ES-2RS	\$74,9		
GAC 90 S	\$52,3				
GAC120 S	\$75,5				

**B&R****0 212 280 30 73 - 0 212 268 33 99 - 0 212 280 96 85**  
**BARKIN RULMAN HIZMETLERİ SAN.TİC.LTD.ŞTİ****Adres : OTO SANAYİ SİTESİ ULUBAŞ CAD. NO.3 4.LEVENT/İSTANBUL****LÜTFEN İSKONTO ORANLARINIZI SORUNUZ**

PARÇA NO	FİYAT/USD
PHS 05	\$1,5
PHS 06	\$1,5
PHS 08	\$2,0
PHS 10	\$2,3
PHS 10x1,25	\$2,3
PHS 12	\$3,1
PHS 12x1,25	\$3,1
PHS 14	\$4,1
PHS 14x1,5	\$4,1
PHS 16	\$5,1
PHS 16x1,5	\$5,1
PHS 18	\$7,7
PHS 20	\$9,3
PHS 22	\$12,9
PHS 25	\$16,2
PHS 30	\$24,3

PARÇA NO	FİYAT/USD
PHS 05 L	\$1,5
PHS 06 L	\$1,5
PHS 08 L	\$2,0
PHS 10 L	\$2,3
PHS 10 Lx1,25	\$2,3
PHS 12 L	\$3,1
PHS 12 Lx1,25	\$3,1
PHS 14 L	\$4,1
PHS 14 Lx1,5	\$4,1
PHS 16 L	\$5,1
PHS 16 Lx1,5	\$5,1
PHS 18 L	\$7,7
PHS 20 L	\$9,3
PHS 22 L	\$12,9
PHS 25 L	\$16,2
PHS 30 L	\$24,3

PARÇA NO	FİYAT/USD
POS 05	\$1,5
POS 06	\$1,5
POS 08	\$2,0
POS 10	\$2,3
POS 10x1,25	\$2,3
POS 12	\$3,1
POS 12x1,25	\$3,1
POS 14	\$4,1
POS 16	\$5,1
POS 18	\$7,7
POS 20	\$9,3
POS 22	\$12,9
POS 25	\$16,2
POS 30	\$24,3

PARÇA NO	FİYAT/USD
POS 05 L	\$1,5
POS 06 L	\$1,5
POS 08 L	\$2,0
POS 10 L	\$2,3
POS 10 Lx1,25	\$2,3
POS 12 L	\$3,1
POS 12 Lx1,25	\$3,1
POS 14 L	\$4,1
POS 16 L	\$5,1
POS 18 L	\$7,7
POS 20 L	\$9,3
POS 22 L	\$12,9
POS 25 L	\$16,2
POS 30 L	\$24,3

PARÇA NO	FİYAT/USD
SI 06 E	\$2,6
SI 08 E	\$3,7
SI 10 E	\$4,1
SI 12 E	\$4,1
SI 15 ES	\$6,1
SI 17 ES	\$6,8
SI 20 ES	\$7,4
SI 25 ES	\$11,6

PARÇA NO	FİYAT/USD
SA 06 E	\$2,6
SA 08 E	\$3,7
SA 10 E	\$4,1
SA 12 E	\$4,1
SA 15 ES	\$6,1
SA 17 ES	\$6,8
SA 20 ES	\$7,4
SA 25 ES	\$11,6

PARÇA NO	FİYAT/USD
SIL 06 E	\$2,6
SIL 08 E	\$3,7
SIL 10 E	\$4,1
SIL 12 E	\$4,1
SIL 15 ES	\$6,1
SIL 17 ES	\$6,8
SIL 20 ES	\$7,4
SIL 25 ES	\$11,6

PARÇA NO	FİYAT/USD
SAL 06 E	\$2,6
SAL 08 E	\$3,7
SAL 10 E	\$4,1
SAL 12 E	\$4,1
SAL 15 ES	\$6,1
SAL 17 ES	\$6,8
SAL 20 ES	\$7,4
SAL 25 ES	\$11,6

PARÇA NO	FİYAT/USD
PB 06	\$2,0
PB 08	\$2,5
PB 10	\$3,1
PB 14	\$5,2
PB 16	\$6,3
PB 18	\$9,2
PB 20	\$9,7
PB 22	\$13,4
PB 25	\$17,7

PARÇA NO	FİYAT/USD
NUTR 1542	\$9,7
NUTR 1747	\$10,3
NUTR 2052	\$11,6
NUTR 2562	\$14,2
NUTR 3072	\$16,8
NUTR 3580	\$20,7
NUTR 4090	\$27,1
NUTR 45100	\$30,4
NUTR 50110	\$33,6

**B&R**

0 212 280 30 73 - 0 212 268 33 99 - 0 212 280 96 85

**BARKIN RULMAN HIZDAVAT SAN.TİC.LTD.ŞTİ**

Adres : OTO SANAYİ SİTESİ ULUBAŞ CAD. NO.3 4.LEVENT/İSTANBUL

**LÜTFEN İSKONTO ORANLARINIZI SORUNUZ****BR**

PARÇA NO.	dw	D	C	FİYAT/AD.
<b>GL 30 C-E</b> RV 20/8-10	10	30	14	*
<b>GL 41 C-E</b> RV 202/15.41-20	20	41	20	*



PARÇA NO.	dw	D	C	FİYAT/AD.
<b>RPC-RPE 17</b> LFR 50/5-6	6	17	7	*
<b>RPC-RPE 24</b> LFR 50/8	6	24	11	*
<b>RPC-RPE 35</b> LFR 5201-10	10	35	15,9	*



\* Fiyat sorunuz

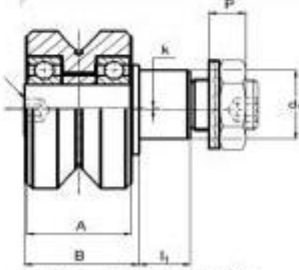
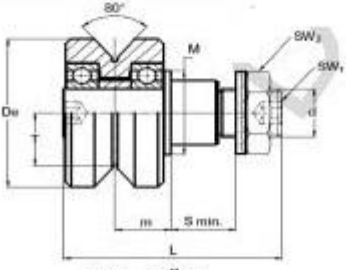

TİP	De	d	T	m	S min.	L	A	B	I1	M	FR	FRR
FR-FRR 22 E1	22	M 6x1	7,7	9,4	9	37	15	18,2	8	14	19,9 \$	21,4 \$
FR-FRR 32 E1	32	M 10x1.25	11,8	12,6	12	50,5	21	24,5	11	20	21,4 \$	24,0 \$
FR-FRR 40 E1	40	M 12x1.25	14,6	15,5	12	59,5	28	30,5	11	22	34,7 \$	36,2 \$
FR-FRR 52 E1	52	M 16x1.5	19,1	19,8	15	69,5	32	36,5	14	28	44,4 \$	46,0 \$
FR-FRR 62 E1	62	M 20x1.5	22,1	20,8	18,5	80,5	36	39,5	17,5	35	56,1 \$	56,1 \$



0 212 280 30 73 - 0 212 268 33 99 - 0 212 280 96 85

**BARKIN RULMAN HIZDAVAT SAN.TİC LTD STİ**

Adres : OTO SANAYİ SİTESİ ULUBAS CAD. NO.3 4.LEVENT/İSTANBUL

**LÜTFEN İSKONTO ORANLARINIZI SORUNUZ**

**BR**



PARÇA NO	dw	d	D	C	FİYAT
LFR 50/4 NPP	5	4	13	6	5,8 \$
LFR 50/5-4 KDD	5	5	16	8	5,8 \$
LFR 50/5-6 NPP	6	5	17	7	4,4 \$
LFR 50/8-6 NPP	6	8	24	11	4,4 \$
R 8.85 2RS	6	8	24,8	17	5,4 \$
LFR 5200-8 KDD	8	10	32	14	6,6 \$
LFR 5201-10 NPP	10	12	35	15,9	6,6 \$
LFR 5201-12 NPP	12	12	35	15,9	6,6 \$
LFR 5201-14 NPP	14	12	39,9	18	6,6 \$
LFR 5204-16 NPP	16	20	52	20,6	12,9 \$
LFR 5206-20 NPP	20	25	72	23,8	17,3 \$
LFR 5206-25 KDD	25	25	72	23,8	17,2 \$
LFR 5301-10 NPP	10	12	42	19	9,1 \$
LFR 5301-20 NPP	20	12	42	19	8,8 \$
LFR 5302-10 NPP	10	15	47	19	10,0 \$

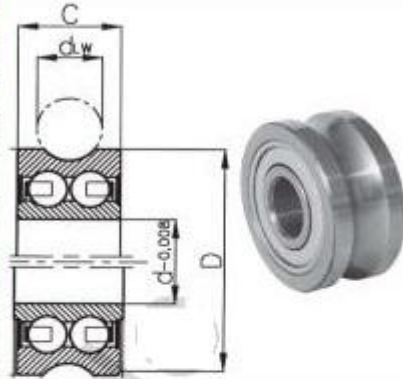

PARÇA NO.	dw	d	D	C	FİYAT
RV 20/7-10	10	7	22	11	5,1 \$
RV 20/8-10	10	8	30	14	5,1 \$
RV 20/8.32-14	10	8	32	14	5,1 \$
RV 201/12.35-16	10	12	35	16	7,3 \$
RV 202/15.38-10	10	15	38	17	8,9 \$
RV 202/15.40-10	10	15	40	18	8,9 \$
RV 202/15.41-20	20	15	41	20	7,9 \$
RV 203/17	20	17	58	25	13,3 \$



PARÇA NO	d	D	C	A1	FİYAT
RM 1 ZZ	4,76	19,56	7,87	7,93	5,5 \$
RM 2 ZZ	9,53	30,73	11,1	12,7	6,7 \$
RM 3 ZZ	12	45,72	15,88	19,05	12,9 \$
RM 4 ZZ	15	59,94	19,05	25,4	20,0 \$



PARÇA NO.	d	D	C	L	FİYAT
SG 15	5	17	8	20,46	2,7 \$
SG 20	6	24	11	28,62	4,2 \$
SG 25	8	30	14	35,77	5,0 \$
SG 35	12	42	19	48,93	8,1 \$

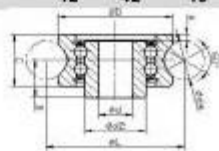

PARÇA NO	D	L	B	FİYAT
JA 7 C	25	43	M8x1	14,2
JA 7 E	25	43	M8x1	14,7

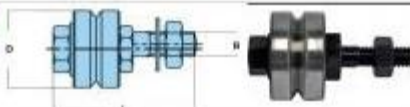



0 212 280 30 73 - 0 212 268 33 99 - 0 212 280 96 85

**BARKIN RULMAN HIZDAVAT SAN.TİC LTD STİ**

Adres : OTO SANAYİ SİTESİ ULUBAŞ CAD. NO.3 4.LEVENT/İSTANBUL

LÜTFEN İSKONTO ORANLARINIZI SORUNUZ

# BR

PARÇA NO	d	D	C	FİYAT
30/5 2RS	5	14	7	5,2 \$
30/6 2RS	6	17	9	5,3 \$
30/8 2RS	8	22	11	6,0 \$
3000 2RS	10	26	12	5,7 \$
3001 2RS	12	28	12	6,7 \$
3002 2RS	15	32	13	8,4 \$
3003 2RS	17	35	14	9,5 \$
3004 2RS	20	42	16	11,2 \$
3005 2RS	25	47	16	12,3 \$
3006 2RS	30	55	19	15,0 \$

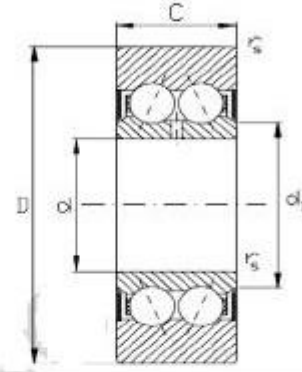

PARÇA NO	d	D	C	FİYAT
LR 50/5 NPPU	5	17	7	6,3 \$
LR 50/6 NPPU	6	19	9	6,3 \$
LR 50/7 NPPU	7	22	10	6,3 \$
LR 50/8 NPPU	8	24	11	6,3 \$
LR 5000 NPPU	10	28	12	6,6 \$
LR 5001 NPPU	12	30	12	6,6 \$
LR 5002 NPPU	15	35	13	7,5 \$
LR 5003 NPPU	17	40	14	7,9 \$
LR 5004 NPPU	20	47	16	8,6 \$
LR 5005 NPPU	25	52	16	9,6 \$
LR 5006 NPPU	30	62	19	12,4 \$
LR 5007 NPPU	35	68	20	15,7 \$
LR 5008 NPPU	40	75	21	17,2 \$



PARÇA NO	d	D	C	FİYAT
LR 5200 NPP	10	32	14	6,2 \$
LR 5201 NPP	12	35	15,9	6,2 \$
LR 5202 NPP	15	40	15,9	7,7 \$
LR 5203 NPP	17	47	17,5	9,8 \$
LR 5204 NPP	20	52	20,6	10,2 \$
LR 204 NPP	20	52	14	5,8 \$
LR 5205 KDD	25	62	20,6	13,7 \$
LR 5206 KDD	30	72	23,8	16,6 \$
LR 5207 KDD	35	80	27	22,2 \$
LR 5208 KDD	40	85	30,2	28,0 \$





0 212 280 30 73 - 0 212 268 33 99 - 0 212 280 96 85

**BARKIN RULMAN HIZMETLERİ SAN.TİC.LTD.ŞTİ**

Adres : OTO SANAYİ SİTESİ ULUBAS CAD. NO.3 4.LEVENT/İSTANBUL

LÜTFEN İSKONTO ORANLARINIZI SORUNUZ

# BR



## VİDALI MİL UÇ RULMANLARI

PARÇA NO	d/mm	D/mm	B/mm	FİYAT
ZKLN1034-2RS	10	34	20	33,8 \$
ZKLN1242-2RS	12	42	25	40,5 \$
ZKLN1545-2RS	15	45	25	41,9 \$
ZKLN1747-2RS	17	47	25	44,9 \$
ZKLN2052-2RS	20	52	28	55,0 \$
ZKLN2557-2RS	25	57	28	60,0 \$
ZKLN3062-2RS	30	62	28	65,0 \$
ZKLN3572-2RS	35	72	34	75,0 \$
ZKLN4075-2RS	40	75	34	85,0 \$
ZKLN5090-2RS	50	90	34	103,0 \$

PARÇA NO	d/mm	D/mm	H/mm	FİYAT
ZARN 1545 TN	15	45	40	70,1 \$
ZARN 1747 TN	17	47	43	72,8 \$
ZARN 2052 TN	20	52	46	75,9 \$
ZARN 2557 TN	25	57	50	77,0 \$
ZARN 3062 TN	30	62	50	88,4 \$
ZARN 3570 TN	35	70	54	94,9 \$
ZARN 4075 TN	40	75	54	100,0 \$
ZARN 4580 TN	45	80	60	119,2 \$
ZARN 50110 TN	50	110	82	159,8 \$

PARÇA NO	d/mm	D/mm	B/mm	FİYAT
ZKLF 1255 2RS	12	55	25	35,4 \$
ZKLF 1560 2RS	15	60	25	54,6 \$
ZKLF 1762 2RS	17	62	25	61,6 \$
ZKLF 2068 2RS	20	68	28	66,0 \$
ZKLF 2575 2RS	25	75	28	73,9 \$
ZKLF 3080 2RS	30	80	28	83,2 \$
ZKLF 3590 2RS	35	90	34	113,5 \$
ZKLF 50115 2RS	50	115	34	173,9 \$